

## 8247WL-39BK/GD/WN

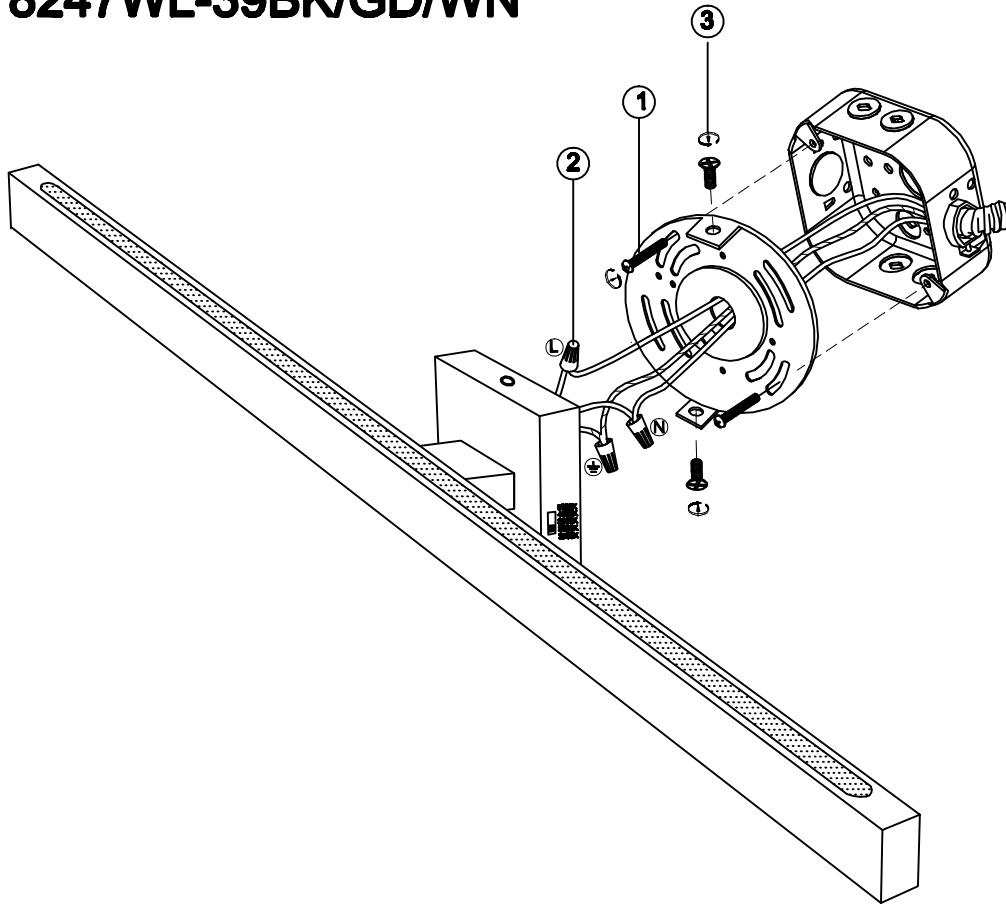

**1:Attach the mounting bracket to the electrical junction box on the wall using the fixing screw supplied.**

**2:Connect all the wiring L/N/G as diagram shows using plastic connector supplied.**

**3:Attach the wall plate to the mounting bracket and screw it using mounting screw supplied on fitting.**

### LED PARAMETERS :

DC - 120V

CRI : 90

Color temperature : 2700/3000/  
3500/4000/5000 K

Power : 30 W

Lumens : 2400 LM

Dimming : 100%-10%, TRIAC