

Instructions Manual

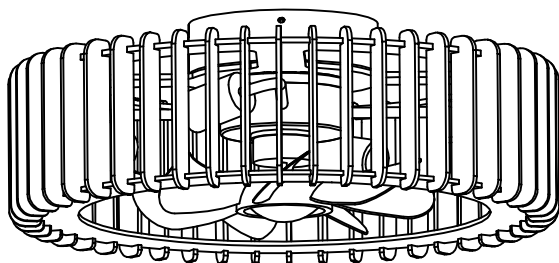

Attention

1. Please read the installation instructions in detail, and cut off the power supply before installation and removal.
2. It is recommended to install by professional electricians. please do not install by yourself if there is no professional knowledge of electricians.
3. Please make sure all screw and nuts are tight during installation.
4. When the product is running, please make sure that no sundries enter into the mainenginc and prevent children from contacting.

Installation Procedure

I. pars list

Before installing the product, please check the following parts and components. If there are no few parts , you can instal them.

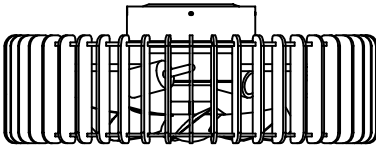

1. Fan host

Remote Control Kit:



Remote Control

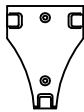

Wall bracket



Self-tapping screws*2



Plastic anchor*2

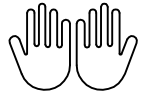

Gloves*2

Installation Kit:

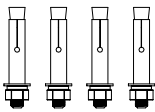

Expansion Bolts*4

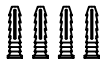

Plastic anchor*4

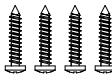

Self-tapping screws*4



Box screw*2



Gasket*2



Wire cap*4

II. Fixed hanger tray

Take the hanger tray from the fan host. According to different ceiling materials and different methods, the hanger must be able to bear more than 30kg after being fixed. It is forbidden to fix it on the unstable ceiling such as gypsum board and aluminum gusset plate, so as to prevent the risk of loosening and falling.

1. For the concrete ceiling, use 8mm impact drill to drill hole first, and then use expansion screws to fix the base. (Fig1)
2. When the wood board ceiling is used, use the wood screw to fix the hanger on the wood beam or the plywood with the thickness more than 9mm. (Fig2)

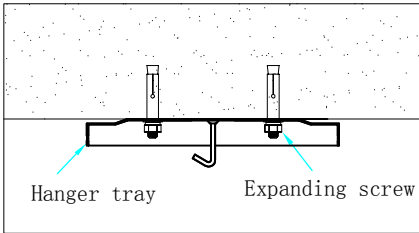

Fig1

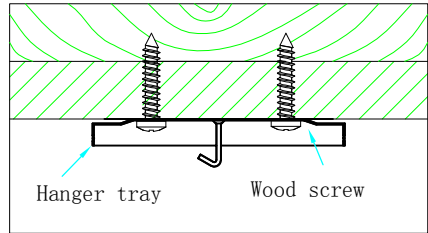

Fig2

III. Installation of fan host

1. Before hang the fan host machine on the hook of the hanger tray. (Fig3)
2. After connecting the wires, install the fan host and the hanger tray together. There are 4 screw holes on the hanger tray and 4 mounting holes on the fan host, the screw need install and tighten, cannot loose. (Fig4)

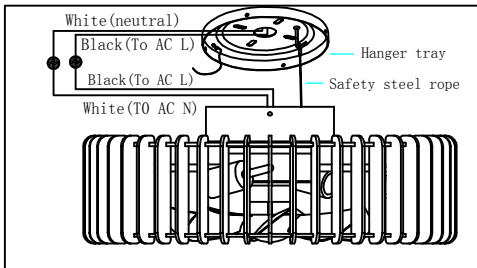

Fig3

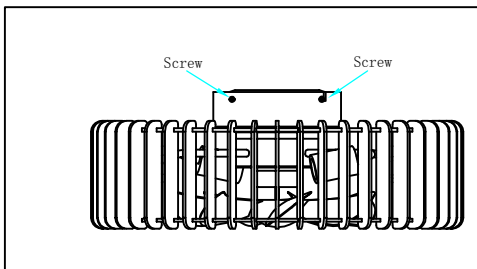

Fig4

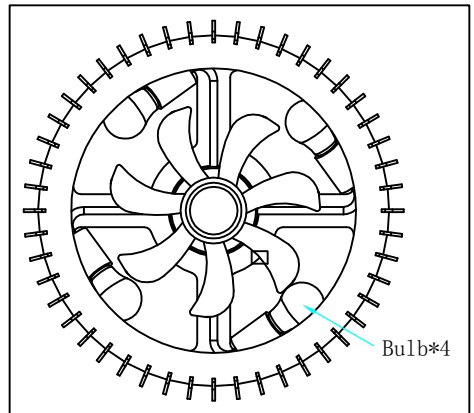

Fig5

IV. Installation of bulb

Install the bulb in the lamp head through the gap between the fan blades. (Fig5)

V. Remove or installation of Fan Blade

1. Turn right to loosen the nut and remove the blade. (Fig6)
2. Turn left to tighten the nut and installation the blade. (Fig7)

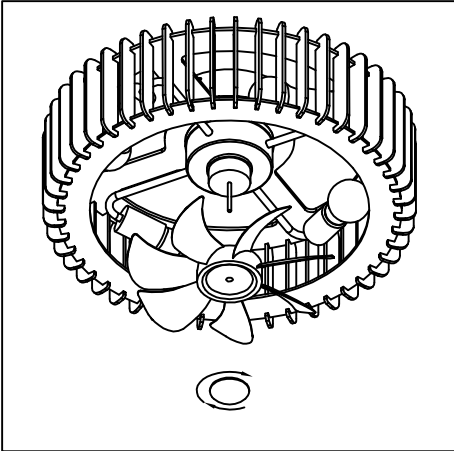

Fig6

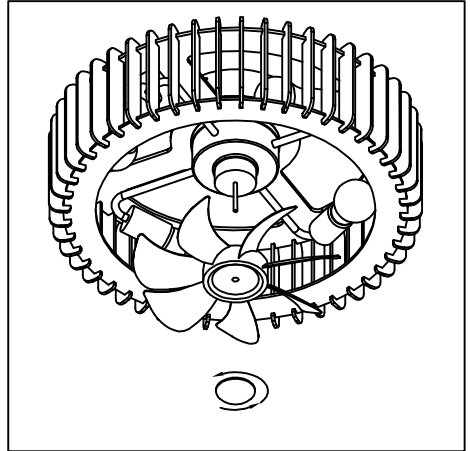

Fig7

VI. Common faults and solutions

1. The fan cannot rotate:
 - Check whether the external power supply is energized;
 - Check whether there is looseness or poor contact at all wiring points;
 - Check whether the remote control is normal, and replace the battery regularly.
2. Fan makes abnormal noise:
 - Check whether the components are damaged or deformed;
 - Check whether there are obstacles inside the fan;
 - Check whether the screw and nuts are loose;
 - Check whether the fan blades are loose;
 - Check whether the components are fastened and installed correctly.
3. Lights are not bright:
 - Check whether the installation and wiring of lamps are correct and whether the wiring is loose;
 - Check whether the lamp head is damaged;
 - Check whether the light source is damaged;
4. Others;
 - After long-term use, other fans will accumulate dust, oil stains and other sundries on the blades and casings. Please clean them regularly; Please cut off the power supply before cleaning.